



Downstream pressure reducer-stabilizer Mod. VRCD

The CSA direct acting pressure reducing valve Mod. VRCD reduces and stabilizes the downstream pressure to a constant value, regardless of flow rate and upstream pressure variations. It can be used for water, air and fluids in general with a maximum working pressure of 40 bar.



Technical features and benefits

- Flanged version DN 50-150.
- Upstream and downstream pressure balanced, to stabilize the downstream pressure to a pre-set (and adjustable) value regardless of upstream pressure variations without creating unwanted upsurges.
- Ductile cast iron for body and cap, piston in stainless steel, seat in stainless steel, guiding bush in stainless steel as well as bolts and nuts.
- Innovative self cleaning piston technology (patent pending) to improve performances reducing maintenance operations.
- Mobile block composed of three components in gun metal/stainless steel obtained by CNC to ensure the maximum accuracy and sliding precision, this is to avoid friction and unexpected leakage.
- Upstream/downstream pressure outlets for gauges.
- Large expansion chamber to reduce noise and to provide an excellent resistance to cavitation.
- Epoxy powder applied using FBT technology.

Applications

- Water distribution systems.
- Buildings and civil installations.
- Irrigations.
- Cooling systems.
- Fire protection systems and in general whenever the pressure reduction has to be ensured.

Operating principle

The operating principle of VRCD is based on a piston sliding into two rings in stainless steel/bronze of different diameters. These rings, tightly connected to the body, form a watertight chamber also known as the compensation chamber which is necessary for the accuracy and stability of the valve.

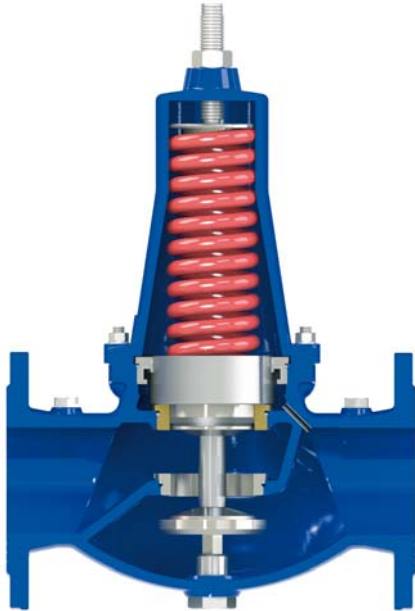

Valve normally open

Without any pressure the VRCD is a normally open valve, where the piston is kept pushed down by the force of the spring located in the cover.

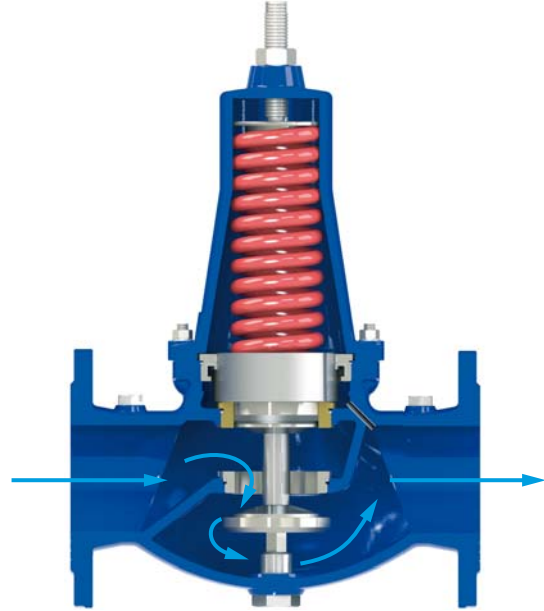

Valve fully open

During working conditions, should the downstream pressure drop below the valve's set point obtained by the compression of the spring, the VRCD will open completely allowing the full passage.

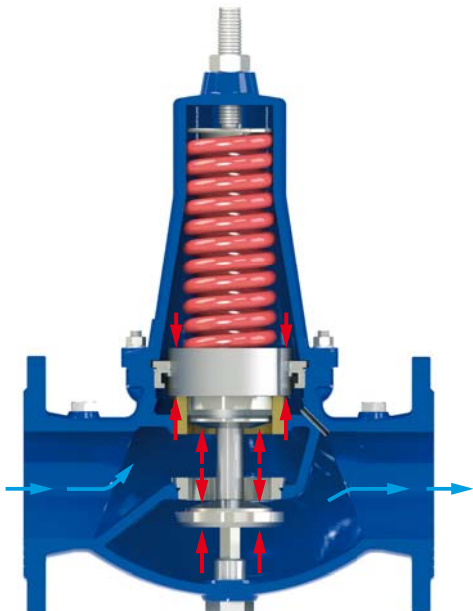

Valve modulating

Should the downstream pressure rise above the valve's set point the resultant of the force obtained by the downstream pressure, acting on the mobile block and the compensation chamber against the spring pushing downwards, will move the obturator producing the required head loss to modulate and stabilize the downstream pressure.

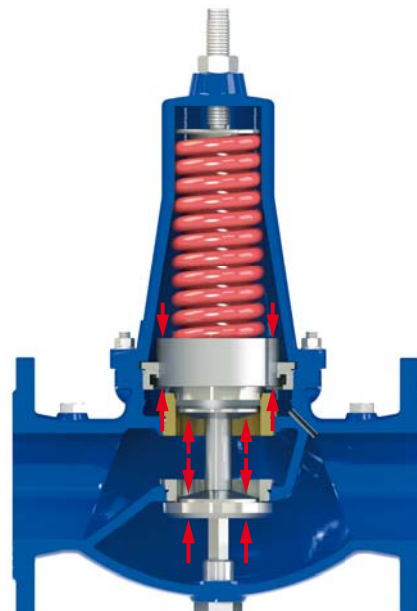

Valve fully closed (static conditions)

Should the water supply be interrupted from downstream the system will work in static conditions, the VRCD will maintain and stabilize the required pressure even with no flow thanks to the pressure balanced technology and compensation chamber.

Technical data

DN mm	50	65	80	100	125	150
Kv (m ³ /h)/bar	20	47	72	116	147	172

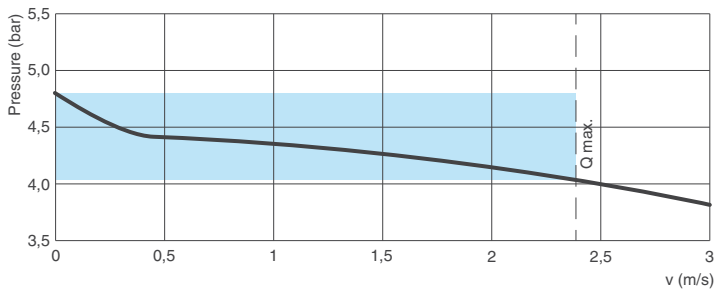
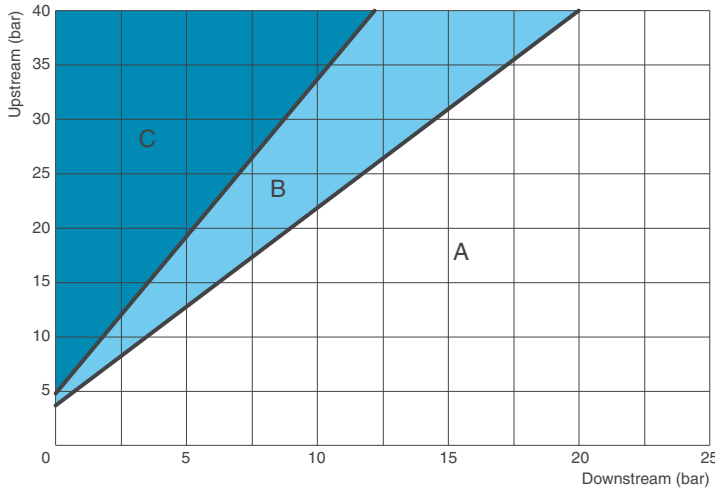

Working conditions

Treated water with a maximum temperature of 70°C.
 Upstream pressure (inlet): maximum 40 bar. Downstream pressure (outlet): adjustable from 1,5 to 6 bar or from 5 to 12 bar.
 Higher downstream pressure values on request.

Recommended flow rate

DN (mm)	50	65	80	100	125	150
Flow rate min. (l/s)	0,3	0,5	0,8	1,2	1,8	2,6
Flow rate max. (l/s)	4,7	8,0	12	18	29	42
Exceptional (l/s)	6,9	11	17	27	42	61

Weights and dimensions

DN (mm)	50	65	80	100	125	150
A (mm)	230	290	310	350	400	450
B (mm)	83	93	100	110	135	150
C (mm)	280	320	350	420	590	690
Weight (Kg)	12	19	24	34	56	74

Values are approximate, consult CSA service for more details.

Head loss coefficient

Kv coefficient representing the flow rate which is flowing through the valve fully open, and producing a head loss of 1 bar.

Cavitation chart

- A: Recommended working conditions;
- B: Incipient cavitation;
- C: Damage cavitation.

Ensure that the working point, obtained connecting upstream (y axis) and downstream (x axis) pressure conditions, falls on the A zone with the smallest valve to meet the required flow.

The chart is to be used for valves modulating with an opening percentage between 35-40% at standard water temperature and elevation below 300 m. For continuous pressure reduction the maximum allowed Δp shall not exceed 24 bar.

Reduced pressure falloff

The plot is showing the reduced pressure falloff that occurs through the valve when the flow increases. Ensure that the operating conditions fall on the area depicted in blue for the recommended fluid flow velocity through the valve.

Standard

Certified and tested in compliance with EN 1074/5.
 Flanges according to EN 1092/2. Epoxy painting applied through fluidized bed technology blue RAL 5005.
 Changes on flanges and painting on request.

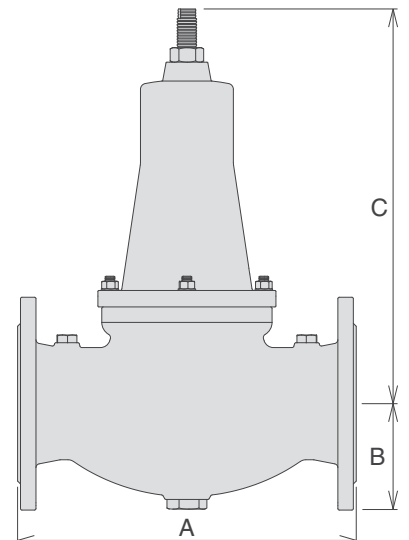

Technical details

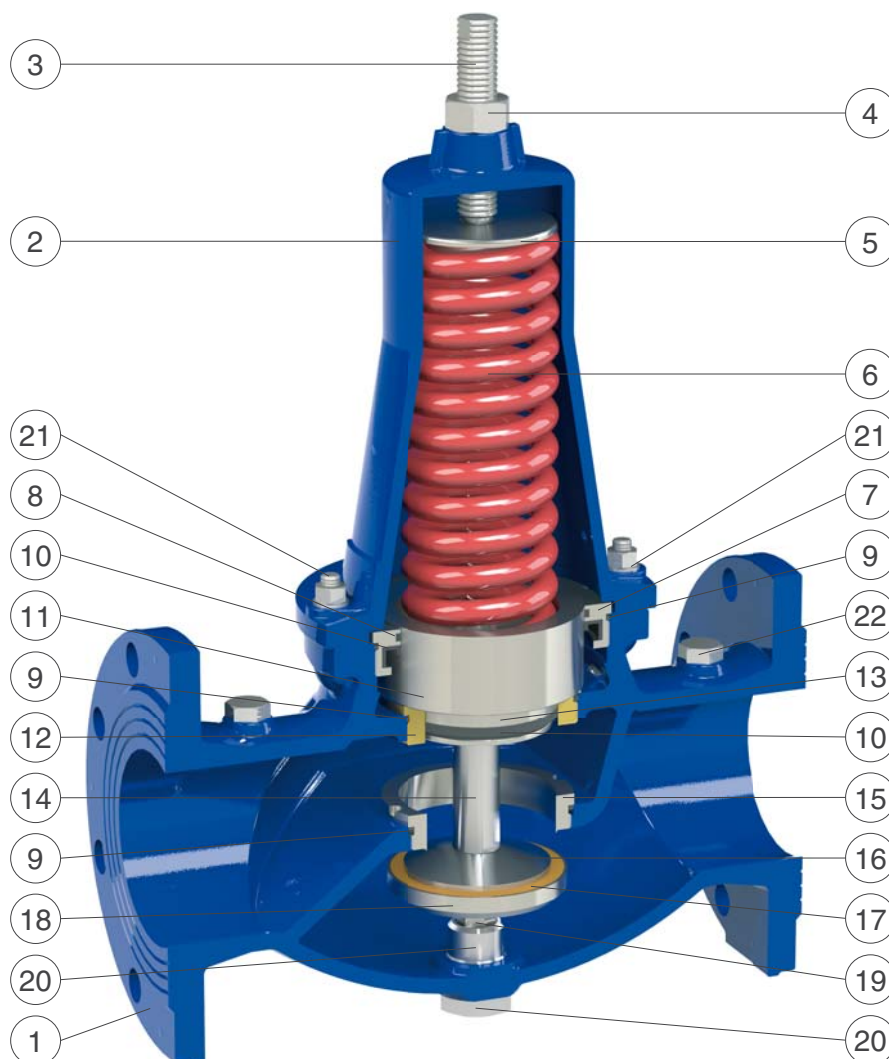

N.	Component	Standard material	Optional
1	Body	ductile cast iron GJS 500-7 or GJS 450-10	
2	Cap	ductile cast iron GJS 500-7 or GJS 450-10	
3	Driving screw	stainless steel AISI 304	stainless steel AISI 316
4	Nut	stainless steel AISI 304	stainless steel AISI 316
5	Spring guide	stainless steel AISI 303	stainless steel AISI 316
6	Spring	spring painted steel 52SiCrNi5	
7	Main bush	stainless steel AISI 304	stainless steel AISI 316
8	Sliding ring	PTFE	
9	O-rings	NBR	EPDM/Viton
10	Gasket	NBR	EPDM/Viton
11	Upper piston	s.s. AISI 303 (bronze CuSn5Zn5Pb5 for DN 125-150)	stainless s. AISI 303/316
12	Lower ring	bronze CuSn5Zn5Pb5	stainless s. AISI 304/316
13	Lower piston	stainless steel AISI 303	stainless steel AISI 316
14	Spacer	stainless steel AISI 303	stainless steel AISI 316
15	Obturator sealing seat	stainless steel AISI 304	stainless steel AISI 316
16	Gasket support	stainless steel AISI 303	stainless steel AISI 316
17	Plane gasket	NBR (polyurethane for PN 25-40)	
18	Gasket holder	stainless steel AISI 303	stainless steel AISI 316
19	Guiding shaft	stainless steel AISI 303	stainless steel AISI 316
20	Driving tap	stainless steel AISI 303	stainless steel AISI 316
21	Studs, nuts and washers	stainless steel AISI 304	stainless steel AISI 316
22	Taps for pressure gauges	stainless steel AISI 316	

The list of materials and components is subject to changes without notice.

Spare parts breakdown

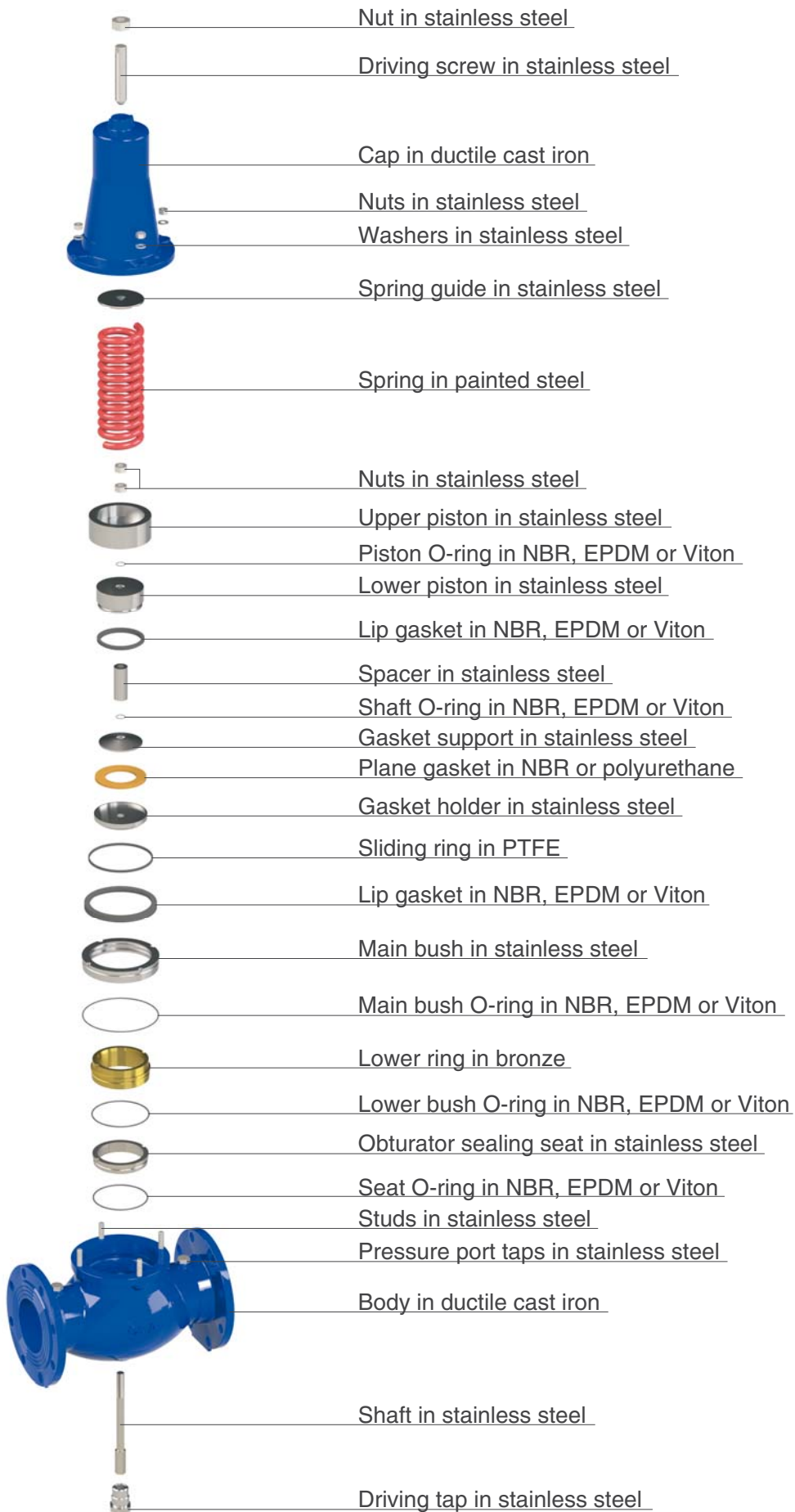

Installation layout

The installation layout of the CSA pressure reducer VRCD includes a filter upstream to prevent the entrance of debris, stones and particles likely to damage the internal components, and sectioning devices. A by-pass line, with one more VRCD, is highly recommended to ensure water supply during maintenance. CSA anti-slam combination air valves FOX AS series are needed before and after the installation as well as CSA pressure relief valve VSM downstream, to discharge possible increase in pressure.



Installation layout

The picture below shows the recommended installation layout of CSA direct acting pressure reducer CSA VRCD installed on a line for level control applications, in combination with equilibrium ball float valve ATHENA. The reason is to prevent cavitation and potential damages arising from high static values acting on it once the level has reached the maximum value, with the valve on its fully closed position.

