

**2020**

Product Catalog





# CONTENTS



About Us 02

Vision / Mission 03

Process 04

Quality 06

EN 124-2 Standard 07

Why Ductile Iron? 08



Manhole Covers 11



Gully Gratings 32



Decorative Products 43



Various Parts 47

## ABOUT US

The foundation of the brand "İSTİKAMET" Which is a preference of leading projects in Turkey and the worldwide established by Hasan Hüseyin ÖKSÜZ in Konya,1996.

Since its establishment, with the principles of reliability, quality, efficiency and innovative vision, İstikamet has become a leader in the casting sector by applying TS 1478 and EN124-2 standard with using advances of high Tech.

İstikamet continues to be a well-known brand in the worldwide with focusing on processes of its services, keeping customer expectations priority. Besides, İstikamet aims at increasing customer satisfaction.

İstikamet which is a manufacturer of manhole covers, gully grates, filters, bollards, tree gratings, etc. produces various kinds of cast iron, ductile iron and steel for metallurgy, mechanics, chemistry, mining, agriculture, automotive industries as well as primarily construction industry.

İstikamet keeps its operations having a laboratory system that controls every production step and applies ISO 9001:2015, ISO 14001:2015, OHSAS 18001:2007, BSI, TSE, TSEK, SASO certificates.

With the knowledge and experience of a half century, İstikamet keeps being a pioneer in Turkey and the World to provide good quality products to customers and increase Turkey's economy without compromising principles of "quality first".



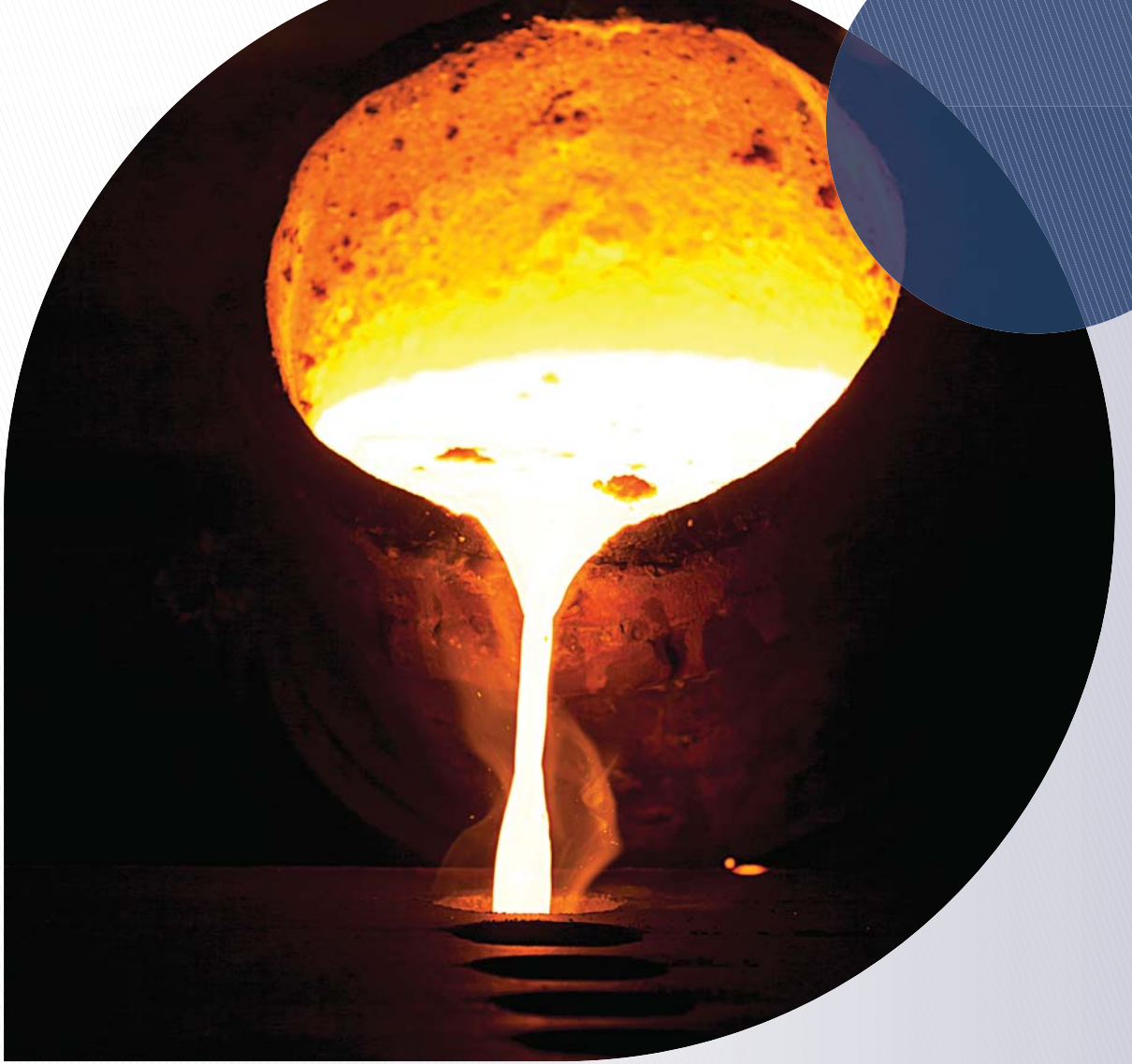

## VISION

It is our vision to be a worldwide effective provider as the leader in the Cast Iron business with customer-oriented and high quality servicing.

## MISSION

Our mission is to meet all customer demands with high quality, modern casting techniques and to develop new products and services in consideration of any future demands.

## COUNTRIES WE EXPORT



## BRIEF HISTORY

Establishing of Cast Iron industry in Konya / Karatay on a facility of

**150 m<sup>2</sup>**

**1966**

Starting of grey iron production with the cupola furnace which has capacity of 500 tons/ year at a facility of

**500 m<sup>2</sup>**

in Habibler/ Istanbul

**1976**

Continuing the grey Iron production with the cupola year at a facility of

**7500 m<sup>2</sup>**

in Kayabasi/ Istanbul

**1997**

Starting ductile cast iron production by getting 1<sup>st</sup> induction furnace with

**500 kg**

**1998**

Taking place in the top

**3 factory**

in the sector, in Turkey

**1998**



Increasing capacity by getting the 2th induction furnace with

**1000 kg**

Become a leader in the industry and maintaining the leadership in Turkey

**2003**

Capacity increased to the 1200 tons/ month by getting new 3th induction furnace with 2000 kg Quality and capacity increased to 180 degree/ hour moulding by getting gradual horizontal moulding system

**2006**

Starting exports

**2007**

Getting 9th in the top 10 exporters list of IMMIB (ISTANBUL MINERAL AND METALS EXPORTERS ASSOCIATION), and maintaining.

**2010**

Capacity increased to 5000 tons/month on an area of **80 000 m<sup>2</sup>** Bozüyük- Bilecik by establishing of second ( double pot) induction furnace with 8 tons and moulding capacity with 250 flasks/ hour.

**2011  
2020**

# PROCESSING

## RAW MATERIALS

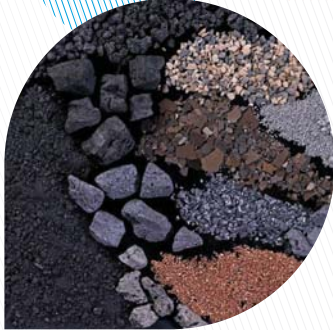

We purchase quality proven materials for our production.

## DESIGN



For the making of model , we use high technological material and CNC machining.

## MELTING



We use induction furnaces to melt pig iron and scrap which give us a 10 tonne melting capacity per hour.

## TRANSPORTATION



When the final products are packaged and ready to go they are loaded onto one of our reliable and efficient couriers.

## QUALITY CONTROL



We follow production with the making all necessary test during production and ship approved materials to our customers.





## MOULDING

We do our production with full automatic moulding machines to reach high quality.

## POURING



The pouring machine is controlling our process automatically.

## PAINTING



The painting system gives the products high corrosion resistance.

## MACHINING

For the making of model, we use high technological material and CNC machining.

## SAND BLASTING



We do our machining with CNC lathe machines and mills machines.

## QUALITY



### OUR QUALITY POLICY

Our company is among Turkey's leaders in Manhole Covers and Gully Gratings. The casting sector we are a part of is one of the significant areas of business in terms of precision and contribution to the country economy. We firmly believe in our contribution to our country's economy through cost effective manufacture process. Our major principles that form the basis of our service policy are as follows:

- ♣ To satisfy customer requirements in a timely and appropriate manner,
- ♣ To inform our portfolio in detail on the use of our products,
- ♣ To preserve our reliability at all times,
- ♣ To serve our customers via the fastest and most economic shipping companies,
- ♣ To employ personnel with highest education level,
- ♣ To move ahead and to adopt continuous optimization as our principal philosophy by means of complying with the quality management system essentials.



**intertek**  
Total Quality. Assured.



## EN 124-2 STANDARD - CLASSES



- 

**A 15**

**Class A 15**  
Access covers and gratings capable of withstanding a 1.5 tonnes test load. For use in areas where only pedestrians and pedal cyclists have access.
- 

**B 125**

**Class B 125**  
Access covers and gratings capable of withstanding a 12.5 tonnes test load. For use in car parks and pedestrian areas where occasional vehicular access is likely.
- 

**C 250**

**Class C 250**  
Access covers and gratings capable of withstanding a 25 tonnes test load. For use in areas where not extending more than 500mm from the kerb face into the carriageway.
- 

**D 400**

**Class D 400**  
Access covers and gratings capable of withstanding a 40 tonnes test load. For use in areas where cars and lorries have access, including carriageways, hard shoulders and pedestrian areas. All units to be either non-rock or silent in operation.
- 

**E 600**

**Class E 600**  
Access covers and gratings capable of withstanding a 60 tonnes test load. For use in areas where heavy wheel loads are imposed such as loading areas, docks or aircraft pavements.
- 

**F 900**

**Class F 900**  
Access covers and gratings capable of withstanding a 90 tonnes test load. For use in areas where very heavy wheel loads are imposed such as aircraft pavements.

## WHY DUCTILE IRON?

### GREY IRON

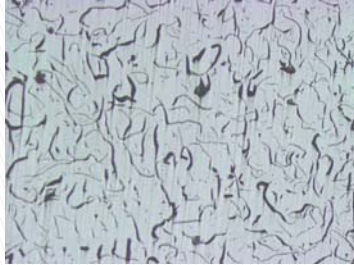

Microstructure of grey iron



### DUCTILE IRON

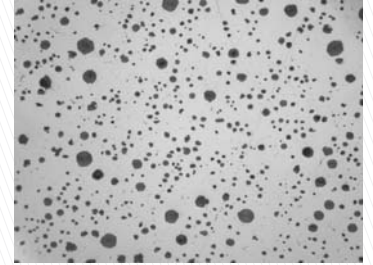

Microstructure of ductile iron



### DUCTILE IRON :

Ductile iron is a family of cast graphitic irons which possess high strength, ductility and resistance to shock. Annealed cast ductile iron can be bent, twisted or deformed without fracturing. Its strength, toughness and ductility duplicate many grades of steel and far exceed those of standard grey irons.

### ADVANTAGES:

- 🔥 High Strength
- 🔥 Resistance to Shock
- 🔥 Ductility
- 🔥 Resistance to Corrosion
- 🔥 Durability
- 🔥 Popular for Industrial Usage

### COMPARISON

	DUCTILE IRON	GREY IRON
Ductility	● ● ●	● ●
High Strength	● ● ●	● ●
High Abrasion Resistance	● ● ●	● ● ●
Resistance to Corrosion	● ● ●	● ● ●
Industrial Usage	● ● ●	● ●

# MANHOLE COVERS



## MANHOLE COVERS

Product Code : 1005

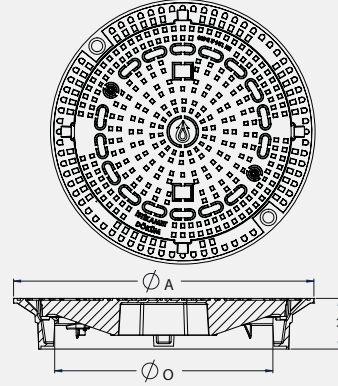

- Ductile iron
- Anti-theft double manual locking
- Self-Leveling
- EPDM rubber gasket



Product Code	Class	Dimensions (mm)			Weight (kg)
		A	O	H	
iD1005	D400	Ø830	Ø600	Ø140	79

Product Code : 1010

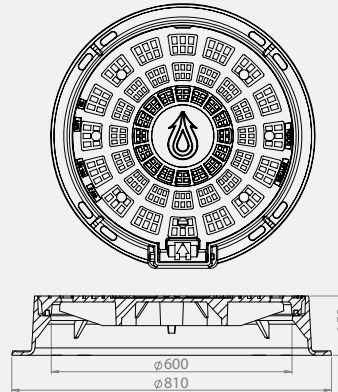

- Ductile iron
- Anti-theft Triple manual locking
- 180° openable double hinged
- EPDM rubber gasket



Product Code	Class	Dimensions (mm)				Weight (kg)
		A	C	O	H	
iD1010	F900	Ø810	Ø695	Ø600	150	115

Product Code : 1021

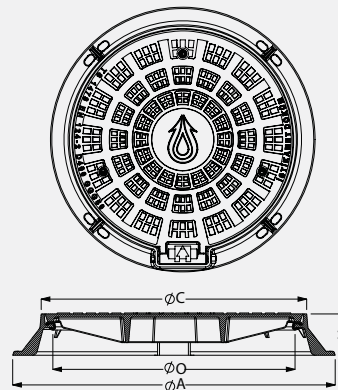

- Ductile iron
- Anti-theft Triple manual locking
- 180° openable double hinged
- EPDM rubber gasket



Product Code	Class	Dimensions (mm)				Weight (kg)
		A	C	O	H	
iD1021	D400	Ø810	Ø695	Ø600	90	88

**MANHOLE COVERS**

Product Code : 1022

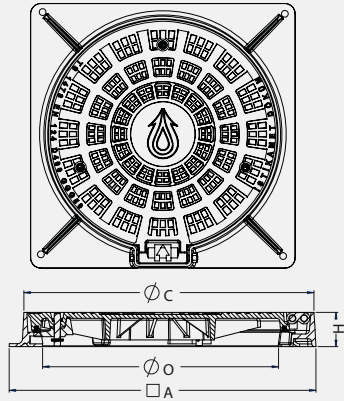

- Ductile iron
- Anti-theft Triple manual locking
- 180° openable double hinged
- EPDM rubber gasket



Product Code	Class	Dimensions (mm)				Weight (kg)
		A	C	O	H	
iD1022	D400	□780	Ø695	Ø600	90	92

Product Code : 1024

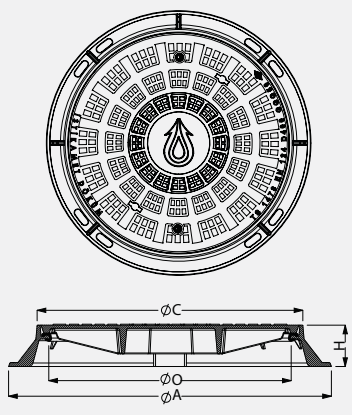

- Ductile iron
- Anti-theft double manual locking
- EPDM rubber gasket



Product Code	Class	Dimensions (mm)				Weight (kg)
		A	C	O	H	
iD1024	D400	Ø810	Ø695	Ø600	100	75

Product Code : 1024-1

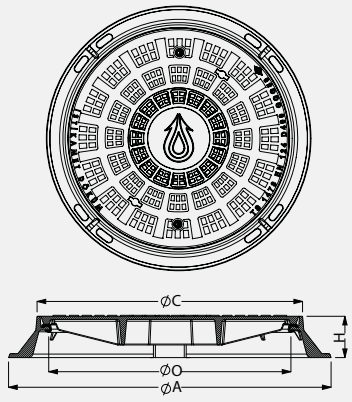

- Ductile iron
- Anti-theft double manual locking
- EPDM rubber gasket



Product Code	Class	Dimensions (mm)				Weight (kg)
		A	C	O	H	
iD1024-1	D400	Ø810	Ø695	Ø600	150	120

## MANHOLE COVERS

Product Code :1035-158

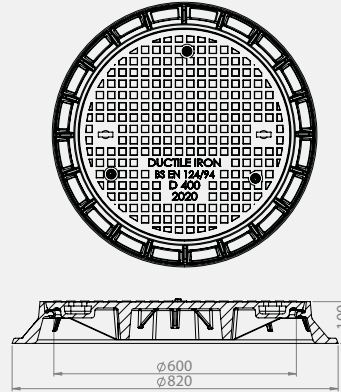

- Ductile iron
- Anti-theft manual locking
- EPDM rubber gasket



Product Code	Class	Dimensions (mm)			Weight (kg)
		A	O	H	
id 1035-158	D400	Ø820	Ø600	Ø100	80

Product Code :1035-2

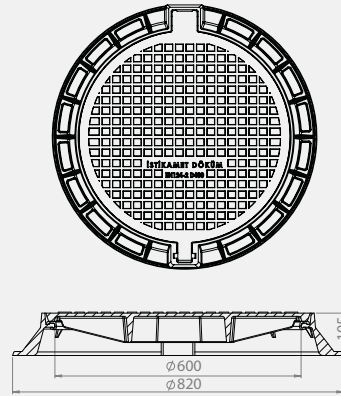

- Ductile iron
- Optional automatic or manual locking at 90 safety blocking, 115° openable hinged
- EPDM rubber gasket



Product Code	Class	Dimensions (mm)				Weight (kg)
		A	C	O	H	
id1035-2	C250	Ø820	Ø675	Ø600	105	52

Product Code : 1041

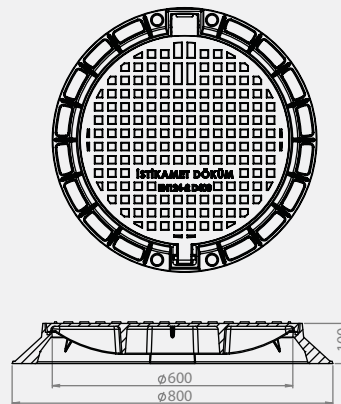

- Ductile iron
- Optional automatic or manual locking at 90 safety blocking, 115° openable hinged
- EPDM rubber gasket



Product Code	Class	Dimensions (mm)				Weight (kg)
		A	C	O	H	
id1041	D400	Ø800	Ø645	Ø600	100	50



## MANHOLE COVERS

Product Code : 1050

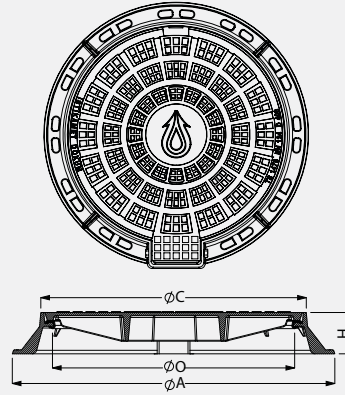

- Ductile iron
- Automatic locking
- 115° openable single hinged
- EPDM rubber gasket



Product Code	Class	Dimensions (mm)				Weight (kg)
		A	C	O	H	
ID1050	D400	Ø805	Ø695	Ø600	80	63

Product Code : 1051

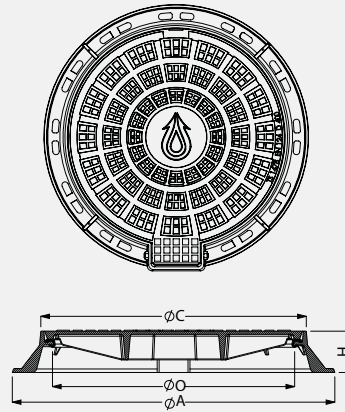

- Ductile iron
- Automatic locking
- 115° openable single hinged
- EPDM rubber gasket



Product Code	Class	Dimensions (mm)				Weight (kg)
		A	C	O	H	
ID1051	D400	Ø805	Ø695	Ø600	80	63

Product Code : 1054

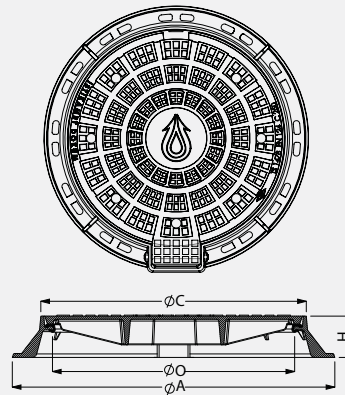

- Ductile iron
- Automatic locking
- 115° openable single hinged
- EPDM rubber gasket



Product Code	Class	Dimensions (mm)				Weight (kg)
		A	C	O	H	
ID1054	C250	Ø805	Ø695	Ø600	80	54

**MANHOLE COVERS**

Product Code : 1055

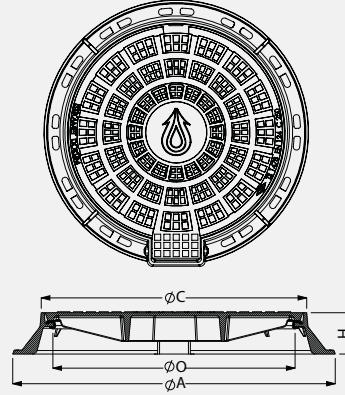

- Ductile iron
- Automatic locking
- 115° openable single hinged
- EPDM rubber gasket



Product Code	Class	Dimensions (mm)				Weight (kg)
		A	C	O	H	
iD1055	C250	Ø805	Ø695	Ø600	80	54

Product Code : 1056

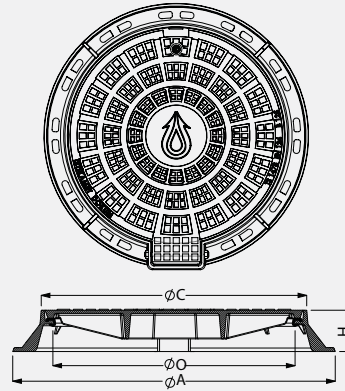

- Ductile iron
- Automatic locking
- 115° openable single hinged
- EPDM rubber gasket



Product Code	Class	Dimensions (mm)				Weight (kg)
		A	C	O	H	
iD1056	B125	Ø805	Ø695	Ø600	60	46

Product Code : 1060

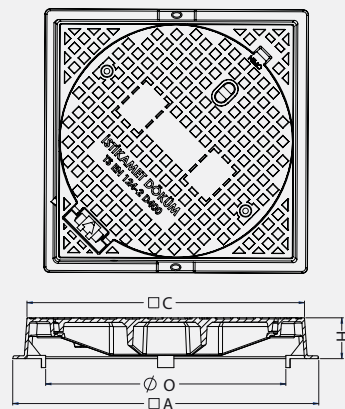
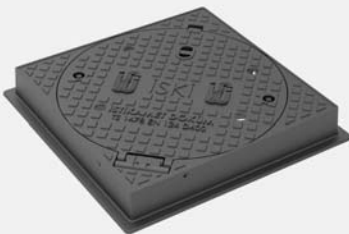

- Ductile iron
- Anti-theft double manual and automatic locking
- 180° openable double hinged
- EPDM rubber gasket



Product Code	Class	Dimensions (mm)				Weight (kg)
		A	C	O	H	
iD1060	D400	□750	Ø680	Ø600	100	75

## MANHOLE COVERS

**Product Code :1061**

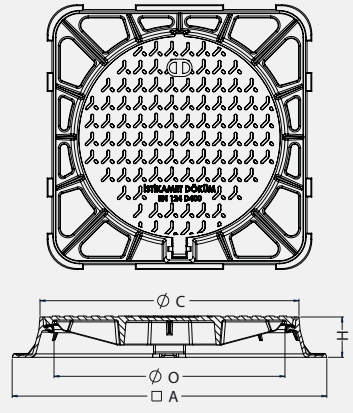
- Ductile iron
- Optional automatic or manual locking at 90 safety blocking, 115° openable hinged
- EPDM rubber gasket

Product Code	Class	Dimensions (mm)				Weight (kg)
		A	C	O	H	
iD1061	D400	□840	Ø650	Ø600	100	63

**Product Code : 1062**

- Ductile iron
- Optional automatic or manual locking at 90 safety blocking, 115° openable hinged
- EPDM rubber gasket

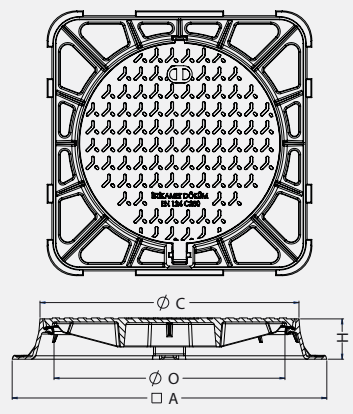
Product Code	Class	Dimensions (mm)				Weight (kg)
		A	C	O	H	
iD1062	C250	□840	Ø650	Ø600	75	53

**Product Code :1073** NEW PRODUCT



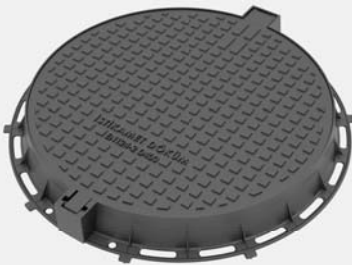
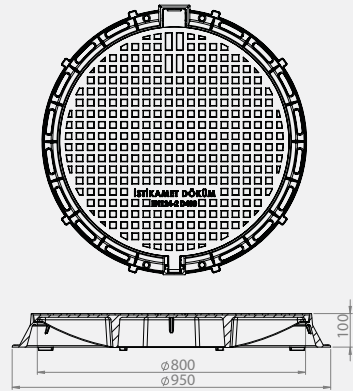

- Ductile iron
- Automatic locking at 90 safety blocking, 115° openable hinged
- EPDM rubber gasket

Product Code	Class	Dimensions (mm)				Weight (kg)
		A	C	O	H	
iD1073	D400	Ø950	Ø800	Ø100	80	85

## MANHOLE COVERS

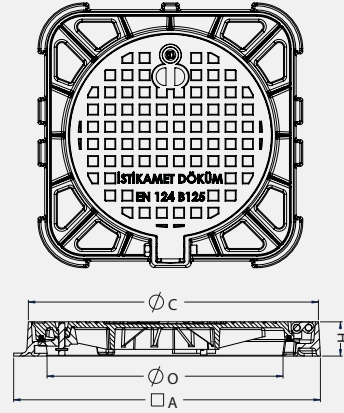
Product Code : 1074



- Ductile iron
- Anti-theft one manual locking
- 115° openable single hinged
- EPDM rubber gasket



Product Code	Class	Dimensions (mm)				Weight (kg)
		A	C	O	H	
ID1074	B125	□600	Ø480	Ø425	50	35

Product Code :1075

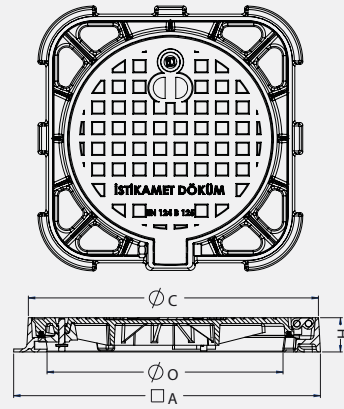

- Ductile iron
- Anti-theft one manual locking
- 115° openable single hinged
- EPDM rubber gasket



Product Code	Class	Dimensions (mm)				Weight (kg)
		A	C	O	H	
ID1075	B125	□500	Ø400	Ø350	50	25

Product Code : 1078

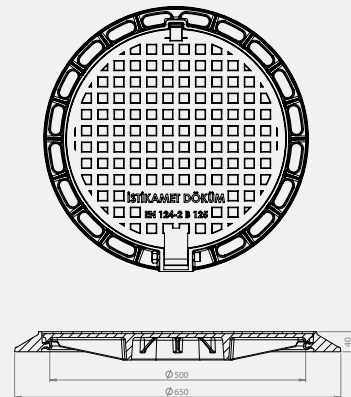

- Ductile iron
- Automatic locking
- 115° openable single hinged
- EPDM rubber gasket



Product Code	Class	Dimensions (mm)			Weight (kg)
		A	O	H	
ID 1078	B125	Ø650	Ø500	Ø40	27

## MANHOLE COVERS

NEW PRODUCT

Product Code : 1094-2

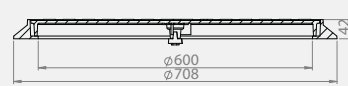
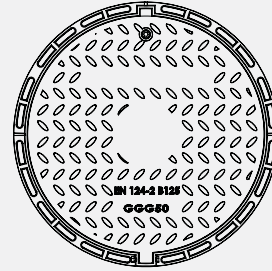

- Ductile iron
- Anti-Theft one manual locking
- 115° openable single hinged



Product Code	Class	Dimensions (mm)			Weight (kg)
		A	O	H	
iD 1094-2	B125	Ø708	Ø600	Ø42	25

NEW PRODUCT

Product Code : 1171

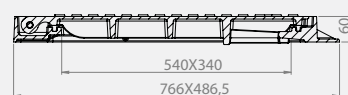
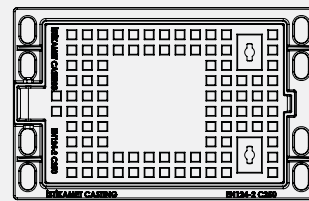

- Ductile iron
- Automatic locking
- 115° openable single hinged
- EPDM rubber gasket



Product Code	Class	Dimensions (mm)			Weight (kg)
		A	O	H	
iD 1171	C250	766X486,5	540X340	60	42

## MANHOLE COVERS

**NEW PRODUCT**

Product Code : 1175

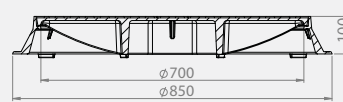
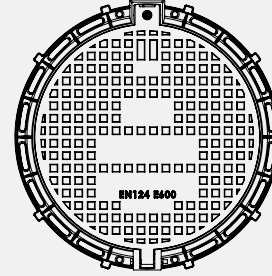

- Ductile iron
- Anti-Theft one manual locking
- 115° openable single hinged
- EPDM rubber gasket



Product Code	Class	Dimensions (mm)			Weight (kg)
		A	O	H	
İD 1175	E600	Ø850	Ø700	Ø100	72

**NEW PRODUCT**

Product Code : 1176

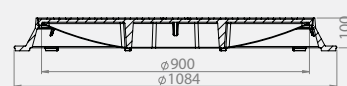
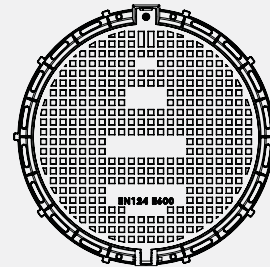

- Ductile iron
- Anti-Theft one manual locking
- 115° openable single hinged
- EPDM rubber gasket



Product Code	Class	Dimensions (mm)			Weight (kg)
		A	O	H	
İD 1176	E600	Ø1084	Ø900	Ø100	115

## MANHOLE COVERS

Product Code : 1043

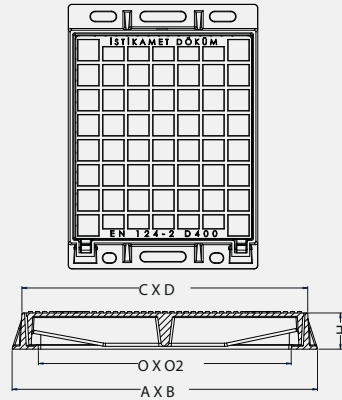
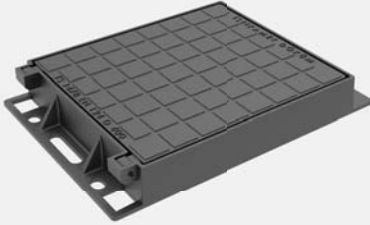

- Ductile iron
- Automatic locking
- 115° openable single hinged
- EPDM rubber gasket



Product Code	Class	Dimensions (mm)						Weight (kg)	
		A	B	C	D	O	O2		H
İD1043	D400	530	740	530	600	450	510	80	54

Product Code : 1045

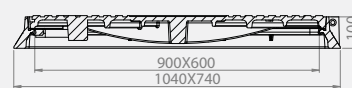
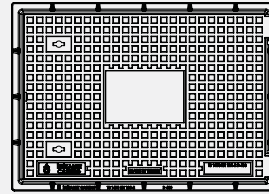

- Ductile iron
- Anti theft automatic locking
- 110° openable single hinged
- EPDM rubber gasket



Product Code	Class	Dimensions (mm)			Weight (kg)
		A	O	H	
İD1045	D400	1040X740	1040X740	100	103

Product Code : 1067

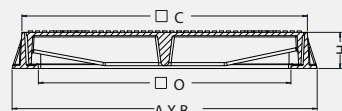
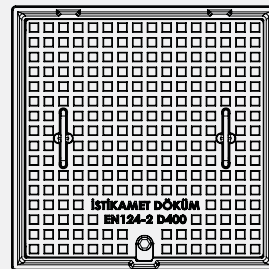
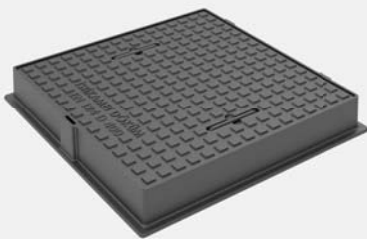

- Ductile iron
- Anti-Theft one manual locking
- EPDM rubber gasket



Product Code	Class	Dimensions (mm)				Weight (kg)
		A	C	O	H	
İD1067	D400	□700	□645	□600	100	62

## MANHOLE COVERS

Product Code : 1068

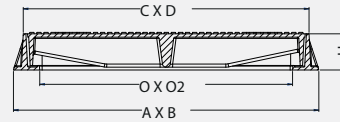
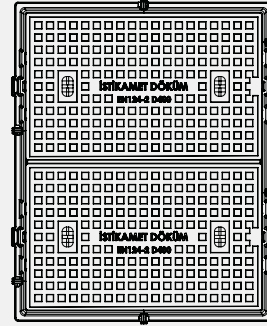
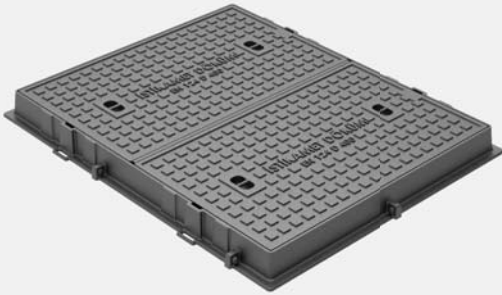

- Ductile iron
- EPDM rubber gasket



Product Code	Class	Dimensions (mm)							Weight (kg)
		A	B	C	D	O	O2	H	
İD1068	D400	900	1110	820	1025	700	910	80	140

Product Code : 1068

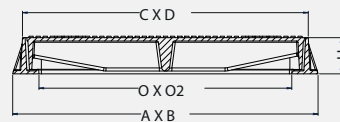
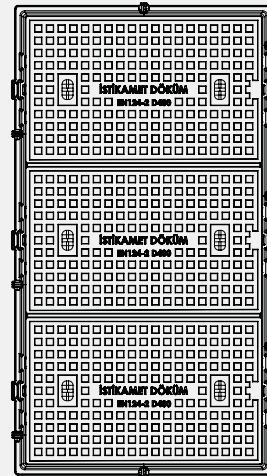

- Ductile iron
- EPDM rubber gasket



Product Code	Class	Dimensions (mm)							Weight (kg)
		A	B	C	D	O	O2	H	
İD1068	D400	900	1610	820	1535	700	1420	80	210



## MANHOLE COVERS

Product Code : 1068

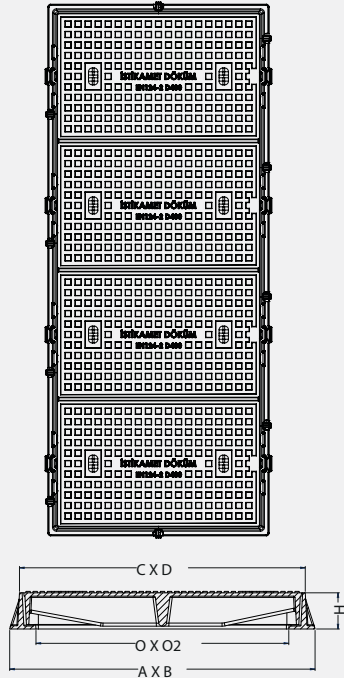

- Ductile iron
- EPDM rubber gasket



Product Code	Class	Dimensions (mm)							Weight (kg)
		A	B	C	D	O	O2	H	
iD1068	D400	900	2110	820	2045	700	1930	80	275

Product Code : 1069

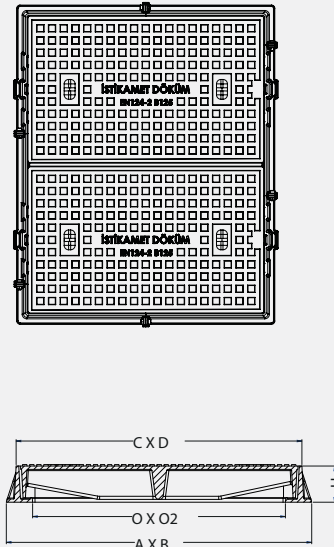
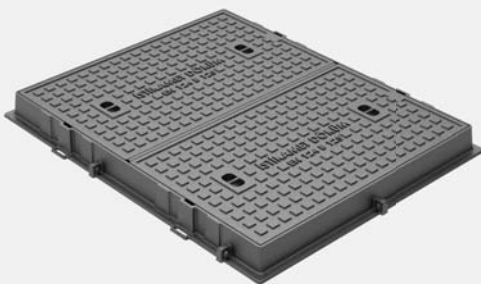

- Ductile iron
- EPDM rubber gasket



Product Code	Class	Dimensions (mm)							Weight (kg)
		A	B	C	D	O	O2	H	
iD1069	B125	900	1110	820	1025	700	920	80	115

## MANHOLE COVERS

Product Code : 1069

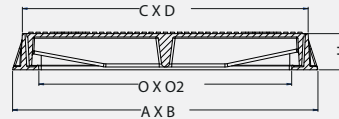
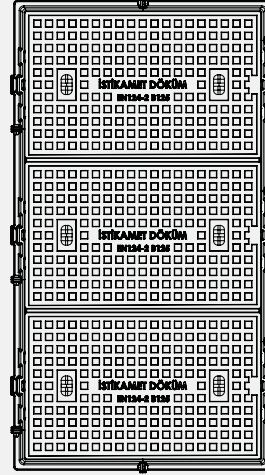

- Ductile iron
- EPDM rubber gasket



Product Code	Class	Dimensions (mm)							Weight (kg)
		A	B	C	D	O	O2	H	
İD1069	B125	900	1610	820	1535	700	1420	80	165

Product Code : 1069

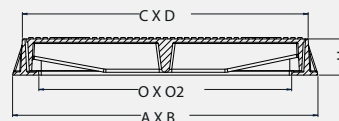
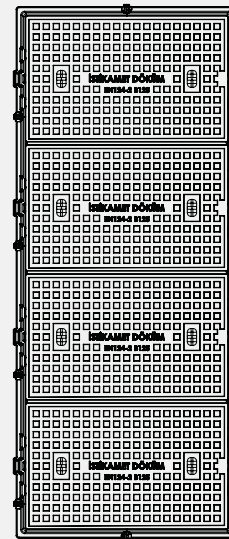

- Ductile iron
- EPDM rubber gasket



Product Code	Class	Dimensions (mm)							Weight (kg)
		A	B	C	D	O	O2	H	
İD1069	B125	900	2110	820	2045	700	1930	80	218

## MANHOLE COVERS

Product Code : 1084

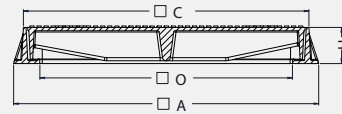
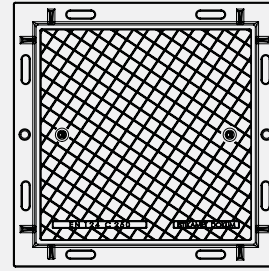
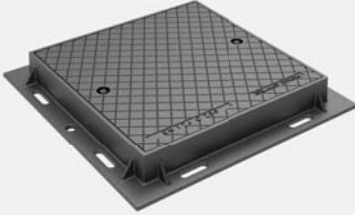

- Ductile iron
- Anti-theft double manual locking
- EPDM rubber gasket



Product Code	Class	Dimensions (mm)				Weight (kg)
		A	C	O	H	
id1084	C250	□700	□680	□510	85	72

Product Code : 1085

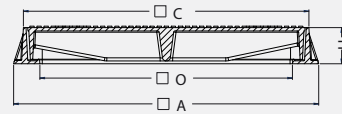
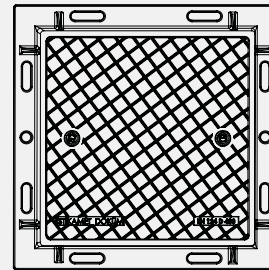
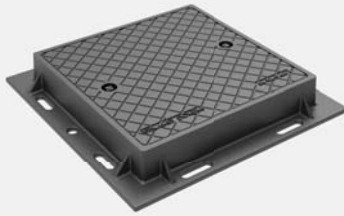

- Ductile iron
- Anti-theft double manual locking
- EPDM rubber gasket



Product Code	Class	Dimensions (mm)				Weight (kg)
		A	C	O	H	
id1085	C250	□580	□470	□400	85	53

NEW PRODUCT

Product Code : 1119

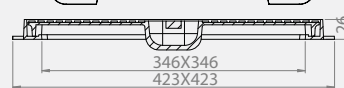
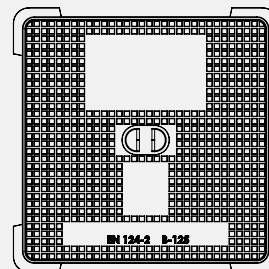
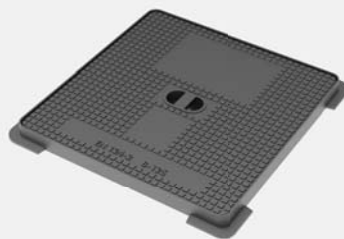

- Ductile iron



Product Code	Class	Dimensions (mm)			Weight (kg)
		A	O	H	
id1119	B125	423X423	346X346	26	8

## MANHOLE COVERS

Product Code : 1124

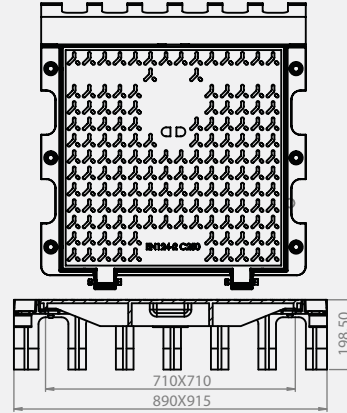
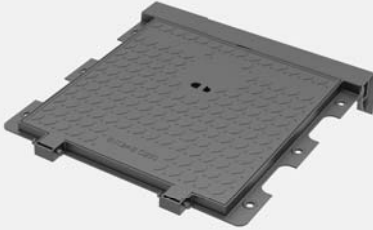

- Ductile iron
- Automatic locking
- 115° openable single hinged
- EPDM rubber gasket



Product Code	Class	Dimensions (mm)			Weight (kg)
		A	O	H	
ID1124	C250	890X915	890X915	198,5	75

Product Code : 1126

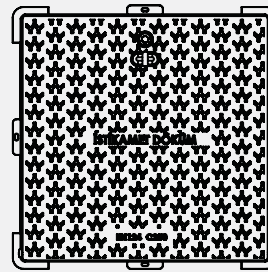
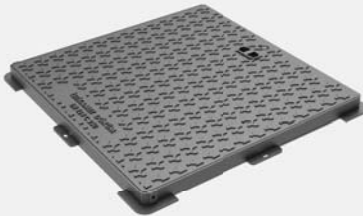

- Ductile iron
- Anti-Theft one manual locking
- 115° openable hidden pin hinged
- EPDM rubber gasket



Product Code	Class	Dimensions (mm)			Weight (kg)
		A	O	H	
ID 1126	D400	Ø740	Ø600	Ø45	61

Product Code : 1127

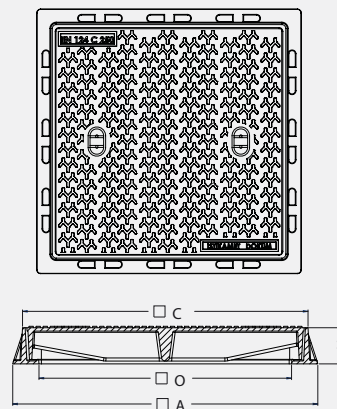
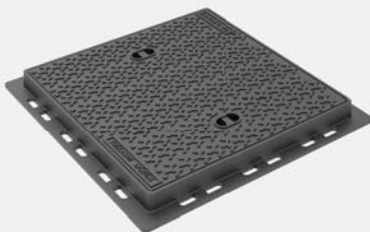

- Ductile iron
- Anti-Theft one manual locking
- 115° openable hidden pin hinged
- EPDM rubber gasket



Product Code	Class	Dimensions (mm)				Weight (kg)
		A	C	O	H	
ID1127	C250	□680	□600	□500	55	40

## MANHOLE COVERS

Product Code : 1128

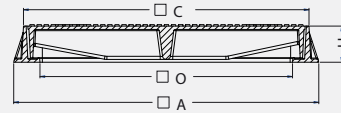
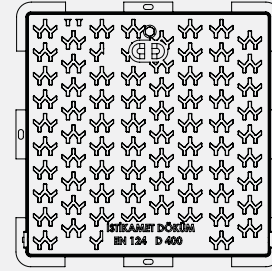
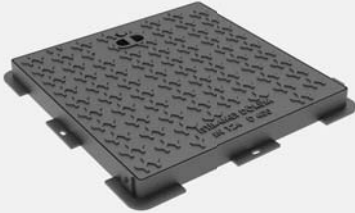

- Ductile iron
- Anti-Theft one manual locking
- 115° openable hidden pin hinged
- EPDM rubber gasket



Product Code	Class	Dimensions (mm)				Weight (kg)
		A	C	O	H	
ID1128	D400	□550	□500	□400	45	36

Product Code : 1129

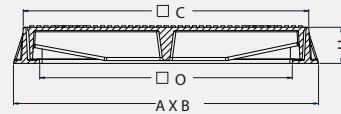
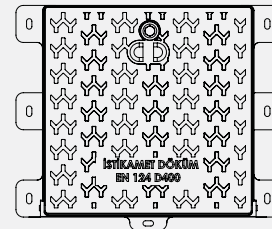

- Ductile iron
- Anti-Theft one manual locking
- 115° openable hidden pin hinged
- EPDM rubber gasket



Product Code	Class	Dimensions (mm)					Weight (kg)
		A	B	C	O	H	
ID1129	D400	400	500	□395	□3204	52	28

NEW PRODUCT

Product Code : 1132

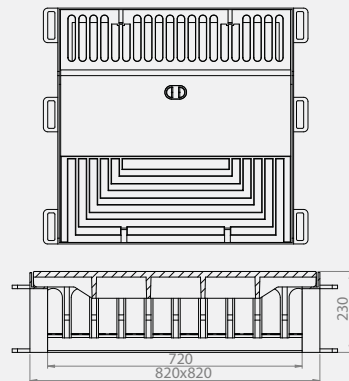

- Ductile iron
- EPDM rubber gasket



Product Code	Class	Dimensions (mm)			Weight (kg)
		A	O	H	
ID1132	C250	Ø820	Ø820	Ø230	70

## MANHOLE COVERS

Product Code : 1143

NEW PRODUCT

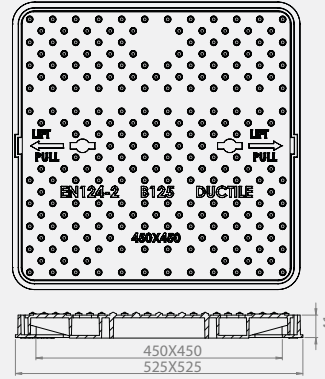
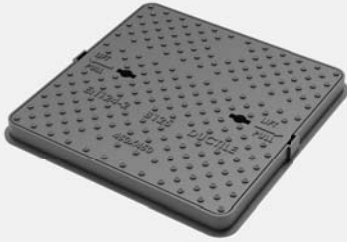

• Ductile iron



Product Code	Class	Dimensions (mm)			Weight (kg)
		A	O	H	
iD1143	B125	525X525	450X450	41	20

Product Code : 1145

NEW PRODUCT

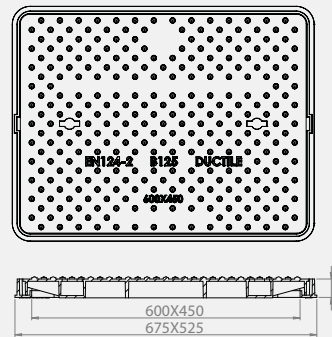
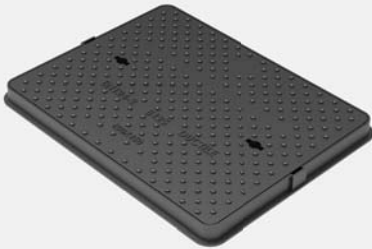

• Ductile iron  
• EPDM rubber gasket



Product Code	Class	Dimensions (mm)			Weight (kg)
		A	O	H	
iD1145	B125	525X525	600X450	41	25

Product Code : 1146

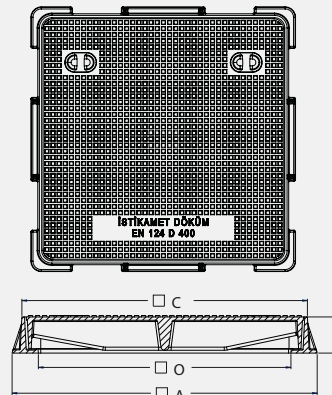

• Ductile iron  
• EPDM rubber gasket



Product Code	Class	Dimensions (mm)				Weight (kg)
		A	C	O	H	
iD1146	D400	□640	□600	□530	75	56

MANHOLE COVERS

NEW PRODUCT

Product Code : 1157

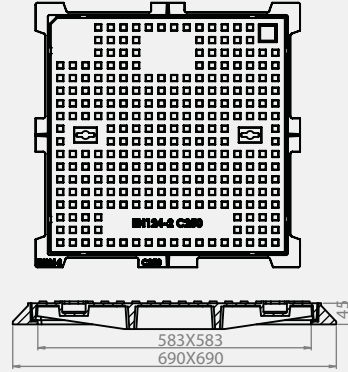
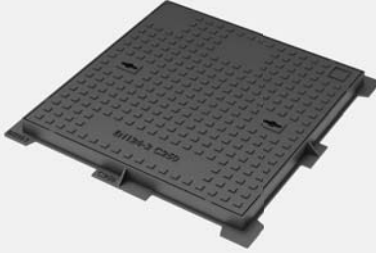

• Ductile iron



Product Code	Class	Dimensions (mm)			Weight (kg)
		A	O	H	
iD1157	C250	690X690	583X583	45	41,5

Product Code : 1158

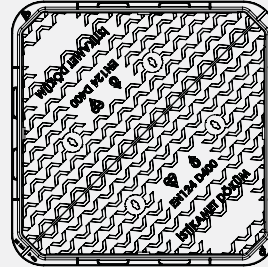
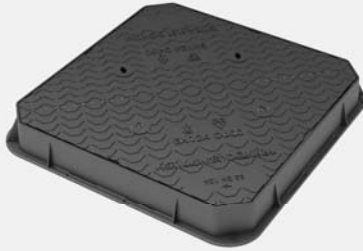

• Ductile iron  
• GRP Sealing Plate



Product Code	Class	Dimensions (mm)			Weight (kg)
		A	O	H	
iD1158	D400	Ø820	Ø750	Ø100	135

Product Code : 1160

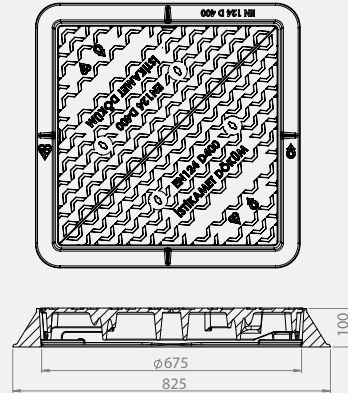

• Ductile iron



Product Code	Class	Dimensions (mm)			Weight (kg)
		A	O	H	
iD1160	D400	Ø825	Ø675	Ø100	109

Product Code : 1161

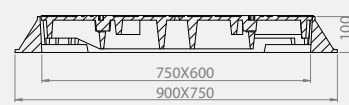
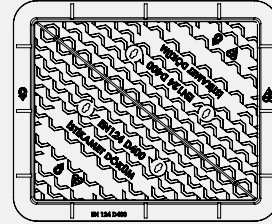
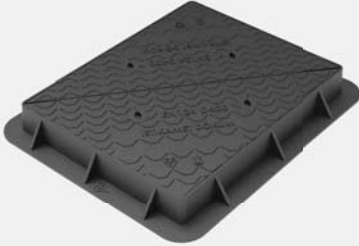
 Ductile iron

Product Code	Class	Dimensions (mm)			Weight (kg)
		A	O	H	
İD1161	D400	900X750	750X600	100	110

NEW PRODUCT

Product Code : 1164

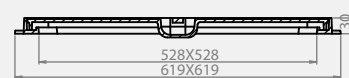
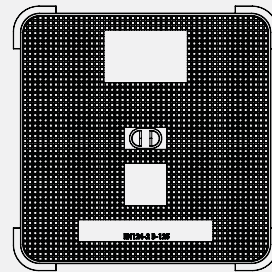

 Ductile iron

Product Code	Class	Dimensions (mm)			Weight (kg)
		A	O	H	
İD1164	B125	619X619	528X528	30	23,5

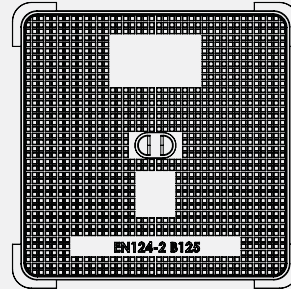
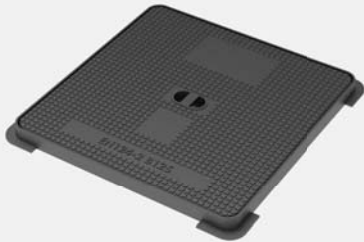

MANHOLE COVERS

Product Code : 1165



• Ductile iron



Product Code	Class	Dimensions (mm)			Weight (kg)
		A	O	H	
İD1165	B125	527X527	445X445	30	15

Product Code : 1166

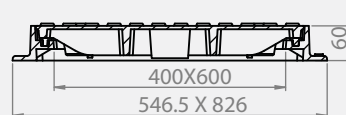
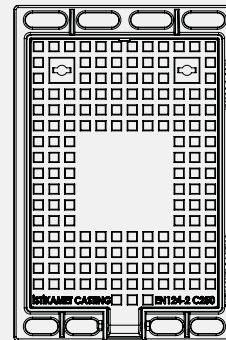

- Ductile iron
- Automatic locking
- 115° openable single hinged
- EPDM rubber gasket



Product Code	Class	Dimensions (mm)			Weight (kg)
		A	O	H	
İD1166	C250	826X546,5	826X546,5	60	51,5

# GULLY GRATINGS



## GULLY GRATINGS

NEW PRODUCT

Product Code : 1131

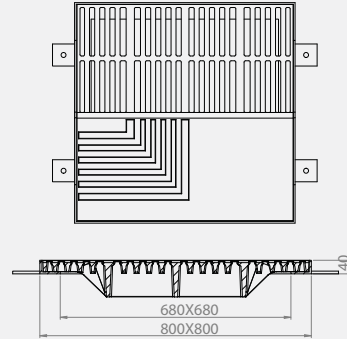
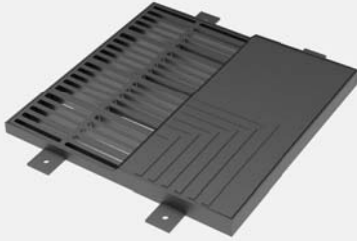

• Ductile iron



Product Code	Class	Dimensions (mm)			Weight (kg)
		A	O	H	
ID1131	D400	800X800	680X680	40	78

Product Code : 2002

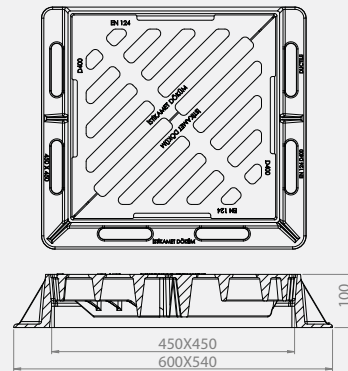

• Ductile iron



Product Code	Type	Class	Dimensions (mm)					Weight (kg)
			A	B	C	O	H	
ID2002	Kerb	D400	540	600	□480	□450	100	47

NEW PRODUCT

Product Code : 2006-15

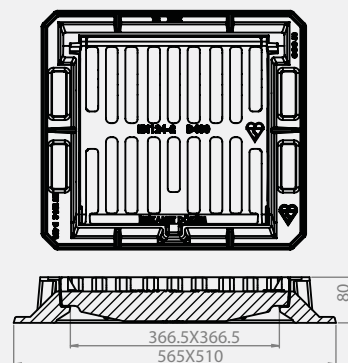

• Ductile iron  
• Automatic locking  
• 116° openable hinge



Product Code	Class	Dimensions (mm)			Weight (kg)
		A	O	H	
ID2006-15	D400	565X510	366,5X366,5	80	30,5

## GULLY GRATINGS

Product Code : 2021

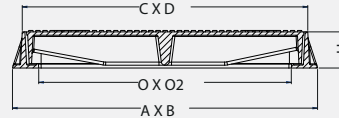
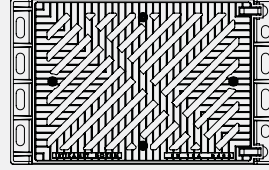
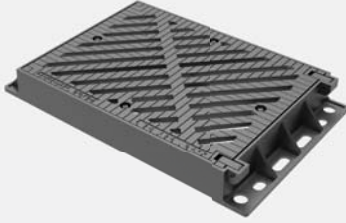

- Ductile iron
- Anti-theft manual locking
- 180° openable double hinged
- EPDM rubber gasket



Product Code	Class	Dimensions (mm)						Weight (kg)
		A	B	D	O	O2	H	
İD2021	D400	610	1000	810	500	700	110	100

Product Code : 2061

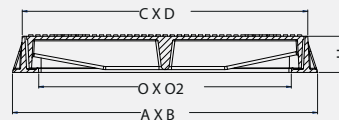
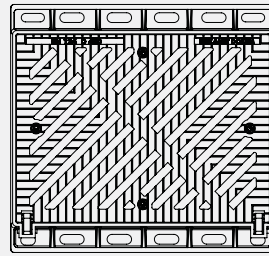
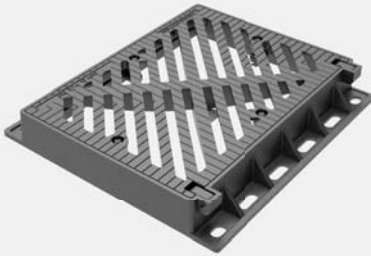

- Ductile iron
- Anti-theft manual locking
- 180° openable double hinged
- EPDM rubber gasket



Product Code	Class	Dimensions (mm)						Weight (kg)
		A	B	D	O	O2	H	
İD2161	D400	760	810	600	500	700	110	115

Product Code : 2121

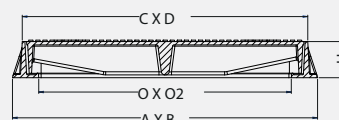
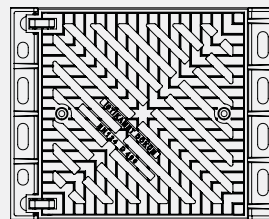
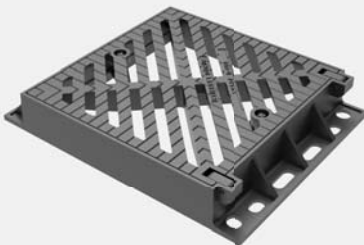

- Ductile iron
- Optional automatic or manual locking
- 115° openable single hinged
- EPDM rubber gasket



Product Code	Class	Dimensions (mm)						Weight (kg)
		A	B	D	O	O2	H	
İD2121	D400	600	750	600	510	510	110	73

## GULLY GRATINGS

Product Code : 2140

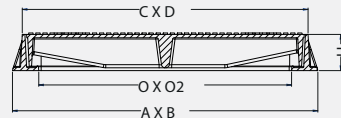
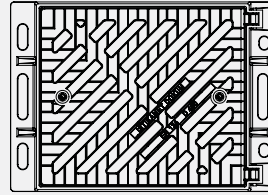
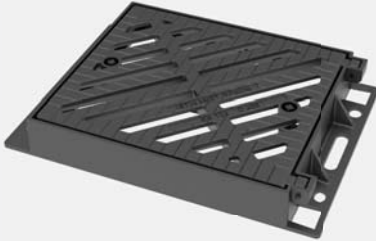

- Ductile iron
- Optional automatic or manual locking
- 115° openable single hinged
- EPDM Rubber gasket



Product Code	Class	Dimensions (mm)						Weight (kg)
		A	B	D	O	O2	H	
iD2140	D400	520	730	600	450	510	100	63

Product Code : 2150

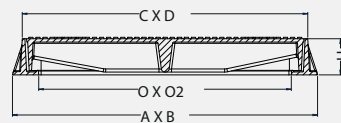
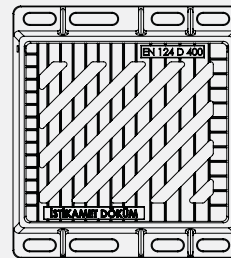

- Ductile iron
- 115° openable hidden pin hinged



Product Code	Class	Dimensions (mm)					Weight (kg)
		A	B	D	O	H	
iD2150	C250	420	500	380	□300	100	37

Product Code : 2151

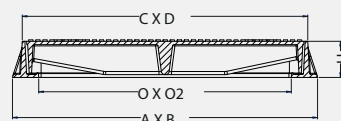
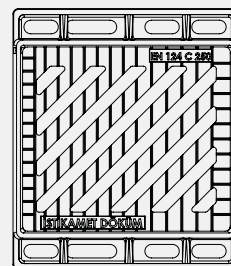

- Ductile iron
- 115° openable hidden pin hinged



Product Code	Class	Dimensions (mm)					Weight (kg)
		A	B	D	O	H	
iD2151	C250	420	500	375	□300	55	27

## GULLY GRATINGS

Product Code : 2152

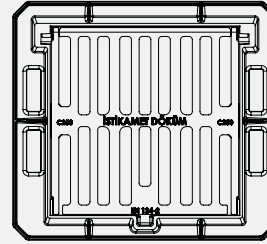

- Ductile iron
- Automatic locking
- 115° openable hinge
- EPDM rubber gasket



Product Code	Class	Dimensions (mm)			Weight (kg)
		A	O	H	
ID2152	D400	568X513	361X369	60	30,5

Product Code : 2153

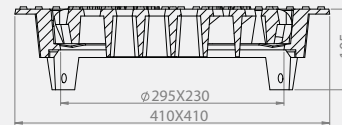
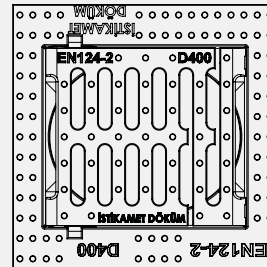

- Ductile iron
- Automatic locking
- 116° openable hinge



Product Code	Class	Dimensions (mm)			Weight (kg)
		A	O	H	
ID2153	D400	410X410	295X230	105	26

Product Code : 2160

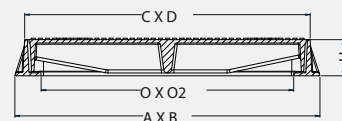
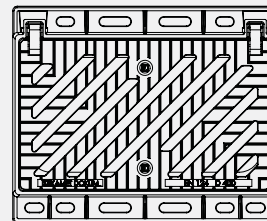
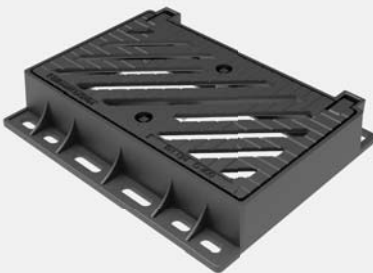

- Ductile iron
- Anti-theft double manual locking
- 180° openable double hinged



Product Code	Class	Dimensions (mm)						Weight (kg)
		A	B	C	O	O2	H	
ID2160	D400	490	600	380	295	545	110	49

## GULLY GRATINGS

Product Code : 2165

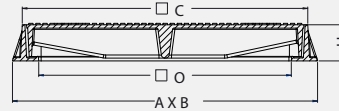
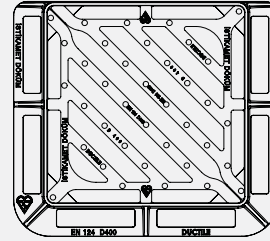

- Ductile iron
- Anti-theft one manual locking
- 115° openable hidden pin hinged



Product Code	Type	Class	Dimensions (mm)					Weight (kg)
			A	B	C	O	H	
ID2165	Kerb	D400	515	580	45	435	100	33

NEW PRODUCT

Product Code : 2172

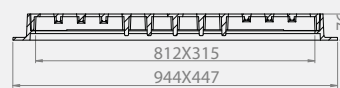
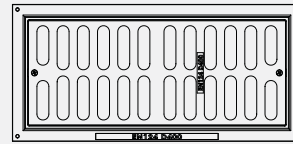

- Ductile iron



Product Code	Class	Dimensions (mm)			Weight (kg)
		A	O	H	
ID2172	D400	944X447	812X315	76	40

NEW PRODUCT

Product Code : 2188

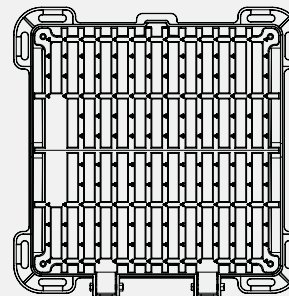

- Ductile iron
- Anti-theft manual locking
- 115° openable single hinged



Product Code	Class	Dimensions (mm)			Weight (kg)
		A	O	H	
ID2188	D400	930X930	745X745	100	85

## GULLY GRATINGS

NEW PRODUCT

Product Code : 2189

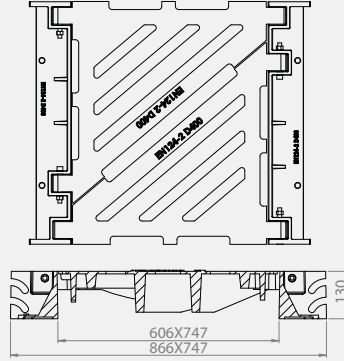
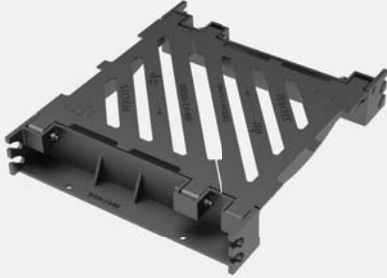

- Ductile iron
- 115° openable single hinged



Product Code	Class	Dimensions (mm)			Weight (kg)
		A	O	H	
iD2189	D400	866X747	606X598	130	91

NEW PRODUCT

Product Code : 2192

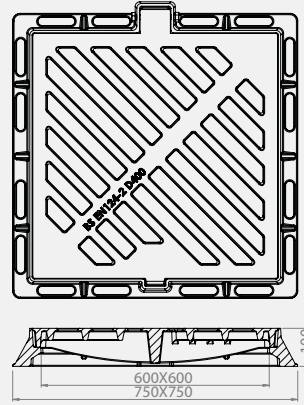
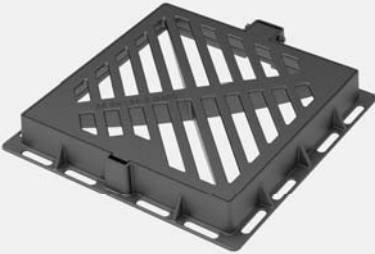

- Ductile iron
- Automatic locking
- 115° openable single hinged



Product Code	Class	Dimensions (mm)			Weight (kg)
		A	O	H	
iD2192	D400	750X750	600X600	100	77

NEW PRODUCT

Product Code : 2193

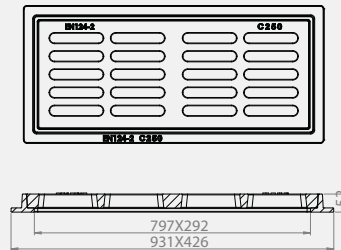
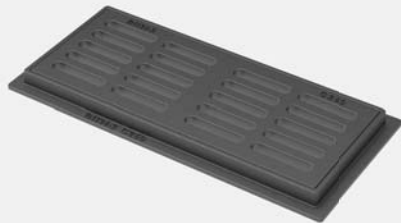

- Ductile iron



Product Code	Class	Dimensions (mm)			Weight (kg)
		A	O	H	
iD2193	C250	931X426	797X292	52	71



## GULLY GRATINGS

NEW PRODUCT

Product Code : 2194

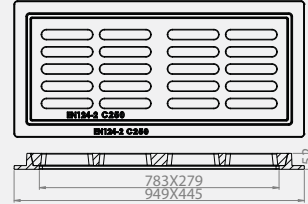

• Ductile iron



Product Code	Class	Dimensions (mm)			Weight (kg)
		A	O	H	
İD2194	C250	949X445	783X279	52	74

NEW PRODUCT

Product Code : 2195

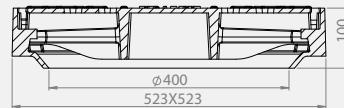
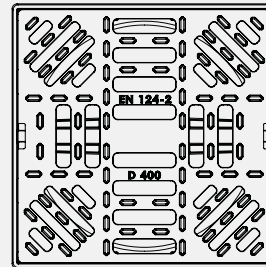

• Ductile iron  
• Automatic locking



Product Code	Class	Dimensions (mm)			Weight (kg)
		A	O	H	
İD2195	D400	523X523	400X400	100	54

NEW PRODUCT

Product Code : 2196

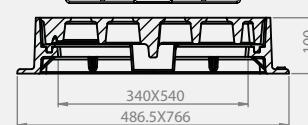
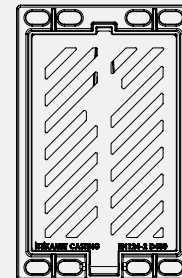

• Ductile iron  
• Automatic locking  
• 115° openable single hinged  
• EPDM rubber gasket



Product Code	Class	Dimensions (mm)			Weight (kg)
		A	O	H	
İD2196	D400	766X486,5	540X340	100	62

## GULLY GRATINGS

Product Code : 2197

NEW PRODUCT

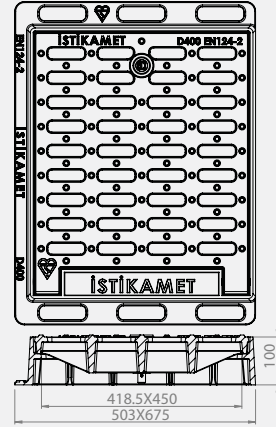

- Ductile iron
- Anti-theft one manual locking
- 115° openable secret pin hinged



Product Code	Class	Dimensions (mm)			Weight (kg)
		A	O	H	
İD2197	D400	675X503	450X418,5	100	52

Product Code : 2198

NEW PRODUCT

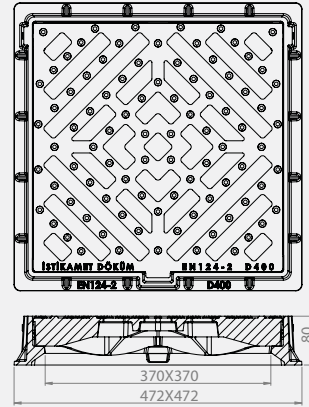
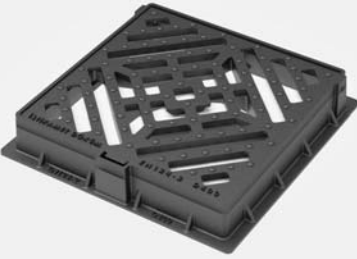

- Ductile iron
- 115° openable secret pin hinged



Product Code	Class	Dimensions (mm)			Weight (kg)
		A	O	H	
İD2198	D400	472X472	415X415	80	26

Product Code : 2199

NEW PRODUCT

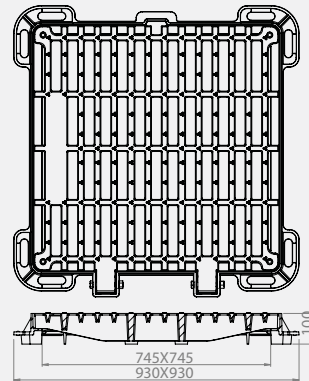

- Ductile iron
- Anti-theft manual locking
- 115° openable single hinged



Product Code	Class	Dimensions (mm)			Weight (kg)
		A	O	H	
İD2199	D400	930X930	745X745	100	85

## GULLY GRATINGS

Product Code : 2221

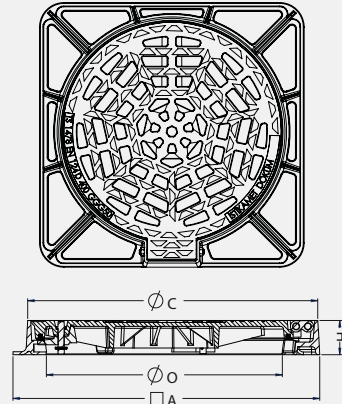

- Ductile iron
- Automatic locking
- 115° openable single hinged
- EPDM rubber gasket



Product Code	Class	Dimensions (mm)				Weight (kg)
		A	C	O	H	
ID2221	D400	750	695	600	100	70

Product Code : 2420

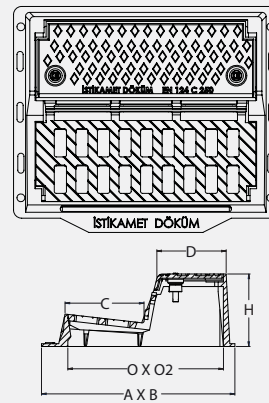

- Ductile iron
- Anti-theft manual locking



Product Code	Type	Class	Dimensions (mm)						Weight (kg)	
			A	B	C	D	O	O2		H
ID2420	Kerb	C250	550	650	195	223	265	535	205	50

Product Code : 2430

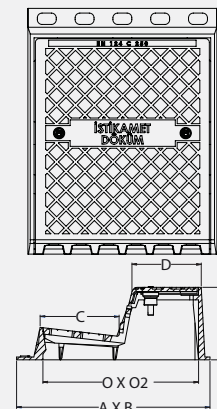
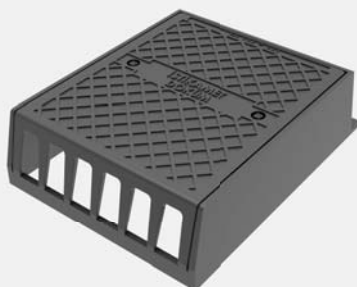

- Ductile iron
- Anti-theft manual locking



Product Code	Type	Class	Dimensions (mm)					Weight (kg)
			A	B	O	O2	H	
ID2430	Kerb	C250	500	650	435	535	180	56

**GULLY GRATINGS**

Product Code : 2440

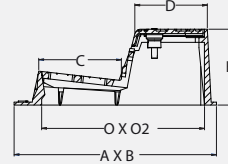
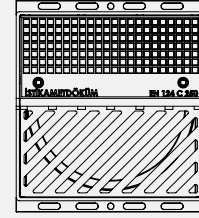

- Ductile iron
- Anti-theft manual locking



Product Code	Type	Class	Dimensions (mm)						Weight (kg)
			A	B	C	D	O	H	
iD2440	Kerb	C250	600	670	300	300	Ø470	150	80

Product Code : 2471

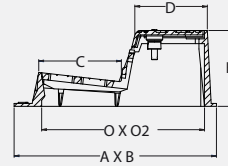
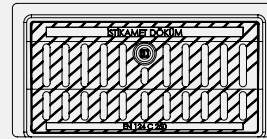
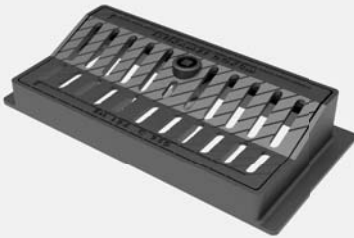

- Ductile iron
- Anti-theft manual locking



Product Code	Type	Class	Dimensions (mm)						Weight (kg)	
			A	B	C	D	O	O2		H
iD2471	Kerb	C250	280	560	100	100	190	465	100	25

Product Code : 2472

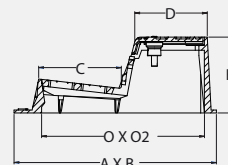
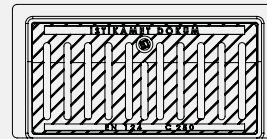
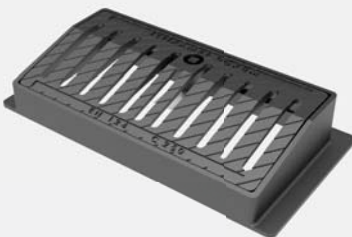

- Ductile iron
- Anti-theft manual locking



Product Code	Type	Class	Dimensions (mm)						Weight (kg)	
			A	B	C	D	O	O2		H
iD2472	Kerb	C250	280	560	160	90	190	465	100	23

# DECORATIVE PRODUCTS

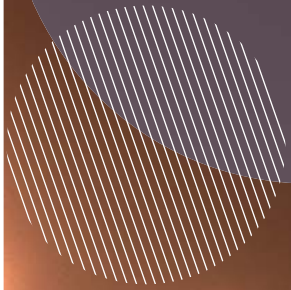

## DECORATIVE PRODUCTS

Product Code : 4040

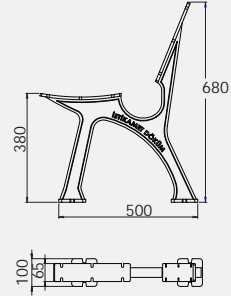

Grey iron



Product Code	Dimensions (mm)			Weight (kg)
	A	B	H	
iD4040	500	670	390	18 (TK)

Product Code : 4050

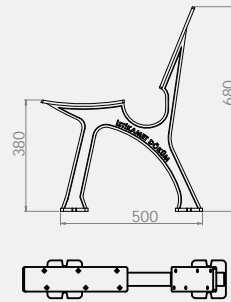

Grey iron



Product Code	Dimensions (mm)			Weight (kg)
	A	B	H	
iD4050	450	660	370	28 (TK)

Product Code : 4130

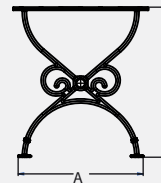

Grey iron



Product Code	Dimensions (mm)		Weight (kg)
	A	B	
iD4130	610	720	34 (TK)

DECORATIVE PRODUCTS

Product Code : 6135

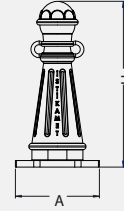

• Ductile iron



Product Code	Dimensions (mm)		Weight (kg)
	A	H	
iD6135	205	500	13

Product Code : 6150

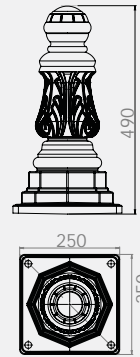

• Ductile iron



Product Code	Dimensions (mm)		Weight (kg)
	A	H	
iD6150	□ 205	490	23

Product Code : 7010

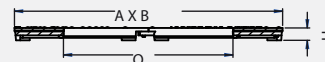
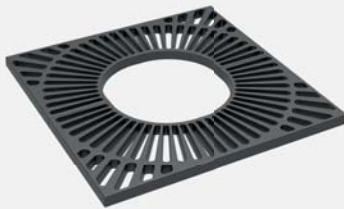

• Grey iron



Product Code	Dimensions (mm)			Weight (kg)
	A	O	H	
iD7010	□ 1000	Ø500	45	125

## DECORATIVE PRODUCTS

Product Code : 7020

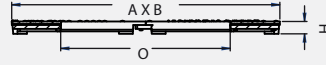

• Ductile iron



Product Code	Dimensions (mm)			Weight (kg)
	A	O	H	
İD7020	□ 820	Ø500	35	75

Product Code : 7030

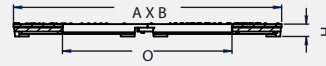

• Ductile iron



Product Code	Dimensions (mm)				Weight (kg)
	A	B	O	H	
İD7030	770	580	Ø300	35	29

Product Code : 7040

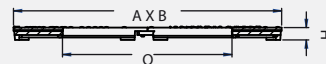

• Ductile iron



Product Code	Dimensions (mm)			Weight (kg)
	A	O	H	
İD7040	□ 580	Ø150	35	24



# VARIOUS PARTS

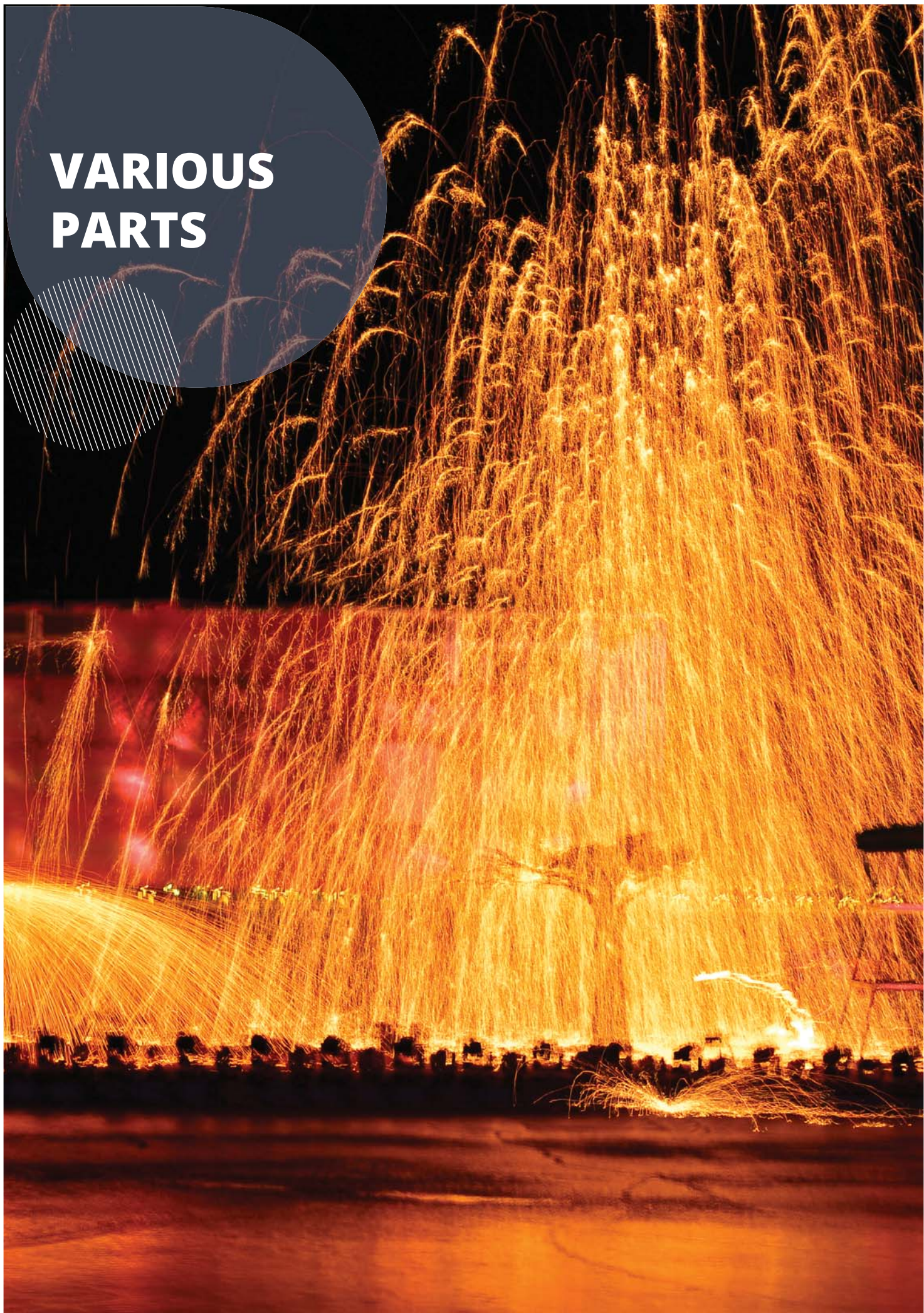

**VARIOUS PARTS**



## CODE CONTENTS

## Manhole Covers



Code	Page
♠ İD 1005	12
♠ İD 1010	12
♠ İD 1021	12
♠ İD 1022	13
♠ İD 1024	13
♠ İD 1024-1	13
♠ İD 1035-158	14
♠ İD 1035-2	14
♠ İD 1041	14
♠ İD 1050	15
♠ İD 1051	15
♠ İD 1054	15
♠ İD 1055	16
♠ İD 1056	16
♠ İD 1060	16
♠ İD 1061	17
♠ İD 1062	17
♠ İD 1073	17
♠ İD 1074	18
♠ İD 1075	18
♠ İD 1078	18
♠ İD 1094-2	19
♠ İD 1171	19
♠ İD 1175	20
♠ İD 1176	20

Code	Page
♠ İD 1043	21
♠ İD 1045	21
♠ İD 1067	21
♠ İD 1068	22-23
♠ İD 1069	23-24
♠ İD 1084	25
♠ İD 1085	25
♠ İD 1119	25
♠ İD 1124	26
♠ İD 1126	26
♠ İD 1127	26
♠ İD 1128	27
♠ İD 1129	27
♠ İD 1132	27
♠ İD 1143	28
♠ İD 1145	28
♠ İD 1146	28
♠ İD 1157	29
♠ İD 1158	29
♠ İD 1160	29
♠ İD 1161	30
♠ İD 1164	30
♠ İD 1165	31
♠ İD 1166	31

## CODE CONTENTS

### Gully Gratings

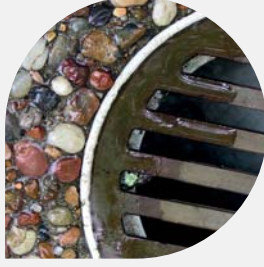

Code	Page
İD 1131	33
İD 2002	33
İD 2006-15	33
İD 2021	34
İD 2061	34
İD 2121	34
İD 2140	35
İD 2150	35
İD 2151	35
İD 2152	36
İD 2153	36
İD 2160	36
İD 2165	37
İD 2172	37
İD 2188	37
İD 2189	38
İD 2192	38
İD 2193	38
İD 2194	39
İD 2195	39
İD 2196	39
İD 2197	40
İD 2198	40
İD 2199	40
İD 2221	41
İD 2420	41
İD 2430	41
İD 2440	42
İD 2471	42
İD 2472	42

### Decorative Products



Code	Page
İD 4040	44
İD 4050	44
İD 4130	44
İD 6135	45
İD 6150	45
İD 7010	45
İD 7020	46
İD 7030	46
İD 7040	46









**İSTİKAMET DÖKÜM A.Ş.**  
**FOUNDRY**

- 📍 Poyra Köyü Poyraosb Mevkii 10.Cadde No:5/101 11302  
Bozüyük-Bilecik/Türkiye
- ☎ +90 228 355 00 25  
+90 228 355 00 26
- ✉ info@istikamet.com.tr

**SALES OFFICE**

- 📍 Topçular mah. Osman gazi cad. B2 blok No:2/91  
Eyüpsultan- İstanbul Türkiye

[www.istikamet.com.tr](http://www.istikamet.com.tr)